

Designer Warmth

Section Page No.

Towel Rails

new 25mm Metallic Finishes	354
new 25mm Colour Finishes	356
25mm Straight	358
25mm Curved	359
25mm Horizontal	360
25mm Sealed Electric	361
new Coloured Valves + Elements	362

Designer Towel Rails

Contemporary Towel Rails

new Azerley	364
new Broxa	365
Kiso	366
Kilpin	367
Tone	367
Brierley	368
Voil	368
Shauna	369
Crambeck	370
Muse	371
Luna	372
Paros	373
Ecstasy	374
Nuance	375

Traditional Towel Rails

Hemsworth	376
Kensington	377
new Kinsley	377

Designer Radiators

new Nostell	378
new Lissett	380
Ovate	381
Adore	382
Medley	384
Symphony	385
Alumina	386
new Espada Aluminium	388
Espada	390

Radiator Valves

Radiator Valves	392
-----------------	-----

What's new and trending this season...

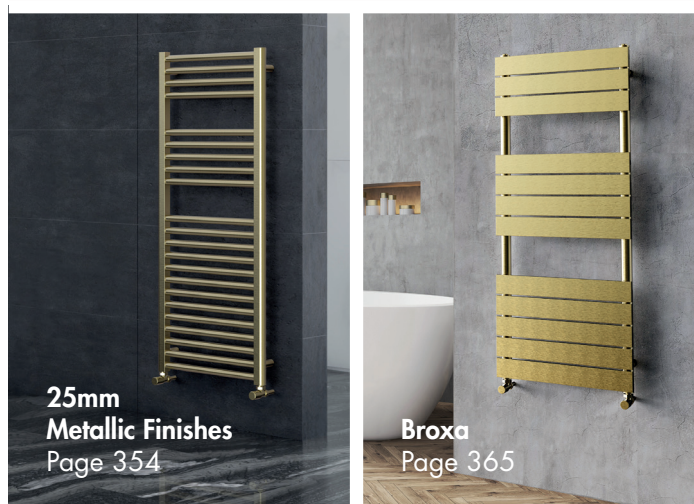

25mm Metallic Finishes
Page 354

Broxa
Page 365



Azerley
Page 364



Nostell
Page 379

Designer Warmth Range Selector

Designer Warmth																
Towel Rails		Heat Source			Finish					Material			Hanging			
Range	Page No.	Heating Only	Dual Fuel	Electric Only	Chrome	Polished Stainless Steel	Black	White	Anthracite	Metallic /Colour Finish	Stainless Steel	Mild Steel	Aluminium	Vertical	Horizontal	
25mm Metallic Finishes	354	●	●	●						●		●		●		
25mm Colour Finishes	356	●	●	●						●		●		●		
25mm Straight	358	●	●	●	●			●				●		●		
25mm Curved	359	●	●	●	●			●				●		●		
25mm Horizontal	360	●	●	●	●				●			●			●	
25mm Sealed Electric	361			●	●							●		●		

Designer Towel Rails																
Azerley	364	●	●	●			●	●	●				●		●	
Broxa	365	●	●	●						●		●		●		
Kiso	366	●	●	●		●					●			●		
Kilpin	367	●	●	●		●					●			●		
Tone	367	●	●	●		●					●				●	
Brierley	368	●	●	●	●							●		●		
Voil	368	●	●	●					●			●		●		
Shauna	369	●	●	●			●	●				●		●		
Crambeck	370	●	●	●	●		●					●		●		
Muse	371	●	●	●	●		●					●		●		
Luna	372	●	●	●				●	●				●	●		
Paros	373	●	●	●	●							●		●		
Ecstasy	374	●	●	●	●			●				●		●		
Nuance	375	●	●	●	●			●				●		●		
Hemsworth	376	●	●	●	●			●				●		●		
Kensington	377	●	●	●	●			●				●		●		
Kinsley	377	●	●	●	●			●				●		●		

Designer Radiators																
Nostell	378	●					●	●	●	●			●	●	●	
Lissett	380	●					●	●	●	●			●	●	●	
Ovate	381	●						●	●			●		●		
Adore	382	●						●				●		●	●	
Medley	384	●						●	●			●		●	●	
Symphony	385	●			●		●	●				●		●		
Alumina Vertical	386	●						●	●				●	●		
Alumina Horizontal	387	●						●	●				●		●	
Espada Aluminium Vertical	388	●						●	●				●	●		
Espada Aluminium Horizontal	389	●						●	●				●		●	
Espada Vertical	390	●						●	●			●		●		
Espada Horizontal	391	●						●	●			●			●	

Designer Warmth Features

There are many features in our designer warmth range. Use the icons to help choose the right option for you.



Guarantees
Our selection of Towel Rails and Radiators have either a 30 or 15 year guarantee.



Build Material
Towel Rails and Radiators are made from either Aluminium, Mild Steel or Stainless Steel.

25mm Towel Rails

Guarantees

15 Years on Towel Rails

Please see page 362 for our range of coloured valves

new



Satin Brushed Nickel



Brushed Brass

All dimensions in mm. All measurements are approximate and subject to standard tolerances.

INSTINCT®

Towel Rails

Heating option supplement applies across all 25mm Straight + 25mm Curved

PHGT25-HE-SUPP	Dual fuel add on cost	£189.00
PHGT25-EO-SUPP	Sealed Electric add on cost	£275.00

25mm Towel Rails

Metallic Finishes + Sizes

Material – Mild Steel
 All heat outputs are shown at 50°C Δt in compliance with BSEN442
 Rear air vent
 Contemporary metallic finishes in our popular 25mm horizontal tube multirail.
 Prices shown are for central heating models

MS

800 x 500mm Straight Towel Rail

		Height	Width	Depth	Watts	Btu/hr	
PHG080-50BBRS	Brushed Brass	800	500	93	275	938	£271.00
PHG080-50GM	Gunmetal	800	500	93	275	1460	£271.00
PHG080-50BN	Satin Brushed Nickel	800	500	93	275	2177	£271.00

1200 x 500mm Straight Towel Rail

		Height	Width	Depth	Watts	Btu/hr	
PHG120-50BBRS	Brushed Brass	1200	500	93	428	938	£391.00
PHG120-50GM	Gunmetal	1200	500	93	428	1460	£391.00
PHG120-50BN	Satin Brushed Nickel	1200	500	93	428	2177	£391.00

1800 x 500mm Straight Towel Rail

		Height	Width	Depth	Watts	Btu/hr	
PHG180-50BBRS	Brushed Brass	1800	500	93	638	938	£572.00
PHG180-50GM	Gunmetal	1800	500	93	638	1460	£572.00
PHG180-50BN	Satin Brushed Nickel	1800	500	93	638	2177	£572.00



Gunmetal

25mm Towel Rails

Guarantees

15 Years on Towel Rails

Please see page 362 for our range of coloured valves

Straight Towel Rails – Colours (Heating Only)

new



Steel Blue



Moss Green



White Sparkle



Satin Black



Anthracite



Satin Black



Cappuccino



Espresso



Matt Black



Grey Sparkle



White Sparkle



Steel Blue



Moss Green

White + Grey Sparkle, Latte, Cappuccino, Mocha and Anthracite have a textured finish, with Espresso and Satin Black being gloss. These finishes are also available on other ranges.

Heating option supplement applies across all 25mm Straight + 25mm Curved

PHGT25-HE-SUPP	Dual fuel add on cost	£189.00
PHGT25-EO-SUPP	Sealed Electric add on cost	£275.00

25mm Towel Rails

Colours + Sizes

Material – Mild Steel

All heat outputs are shown at 50°C Δt in compliance with BSEN442



Rear air vent

Contemporary painted finishes in our popular 25mm horizontal tube multirail.



Prices shown are for central heating models

MS



800 x 400mm Straight Towel Rail

		Height	Width	Depth	Watts	Btu/hr	
PHG080-40ZAT	Anthracite	800	400	93	346	1181	£174.00
PHG080-40ZSB	Satin Black	800	400	93	346	1181	£174.00
PHG080-40ZCA	Cappuccino	800	400	93	346	1181	£174.00
PHG080-40ZEX	Espresso	800	400	93	346	1181	£174.00
PHG080-40ZMB	Matt Black	800	400	93	346	1181	£174.00
PHG080-40ZGS	Grey Sparkle	800	400	93	346	1181	£174.00
PHG080-40ZWS	White Sparkle	800	400	93	346	1181	£174.00
 PHG080-40ZMGN	Moss Green	800	400	93	346	1181	£174.00
 PHG080-40ZSBLU	Steel Blue	800	400	93	346	1181	£174.00

800 x 500mm Straight Towel Rail

		Height	Width	Depth	Watts	Btu/hr	
PHG080-50ZAT	Anthracite	800	500	93	420	1433	£186.00
PHG080-50ZSB	Satin Black	800	500	93	420	1433	£186.00
PHG080-50ZCA	Cappuccino	800	500	93	420	1433	£186.00
PHG080-50ZEX	Espresso	800	500	93	420	1433	£186.00
PHG080-50ZMB	Matt Black	800	500	93	420	1433	£186.00
PHG080-50ZGS	Grey Sparkle	800	500	93	420	1433	£186.00
PHG080-50ZWS	White Sparkle	800	500	93	420	1433	£186.00
 PHG080-50ZMGN	Moss Green	800	500	93	420	1433	£186.00
 PHG080-50ZSBLU	Steel Blue	800	500	93	420	1433	£186.00

1200 x 300mm Straight Towel Rail

		Height	Width	Depth	Watts	Btu/hr	
PHG120-30ZAT	Anthracite	1200	300	93	424	1447	£198.00
PHG120-30ZSB	Satin Black	1200	300	93	424	1447	£198.00
PHG120-30ZCA	Cappuccino	1200	300	93	424	1447	£198.00
PHG120-30ZEX	Espresso	1200	300	93	424	1447	£198.00
PHG120-30ZMB	Matt Black	1200	300	93	424	1447	£198.00
PHG120-30ZGS	Grey Sparkle	1200	300	93	424	1447	£198.00
PHG120-30ZWS	White Sparkle	1200	300	93	424	1447	£198.00
 PHG120-30ZMGN	Moss Green	1200	300	93	424	1447	£198.00
 PHG120-30ZSBLU	Steel Blue	1200	300	93	424	1447	£198.00

1200 x 500mm Straight Towel Rail

		Height	Width	Depth	Watts	Btu/hr	
PHG120-50ZAT	Anthracite	1200	500	93	663	2262	£235.00
PHG120-50ZSB	Satin Black	1200	500	93	663	2262	£235.00
PHG120-50ZCA	Cappuccino	1200	500	93	663	2262	£235.00
PHG120-50ZEX	Espresso	1200	500	93	663	2262	£235.00
PHG120-50ZMB	Matt Black	1200	500	93	663	2262	£235.00
PHG120-50ZGS	Grey Sparkle	1200	500	93	663	2262	£235.00
PHG120-50ZWS	White Sparkle	1200	500	93	663	2262	£235.00
 PHG120-50ZMGN	Moss Green	1200	500	93	663	2262	£235.00
 PHG120-50ZSBLU	Steel Blue	1200	500	93	663	2262	£235.00

1200 x 600mm Straight Towel Rail

		Height	Width	Depth	Watts	Btu/hr	
PHG120-60ZAT	Anthracite	1200	600	93	783	2672	£255.00
PHG120-60ZSB	Satin Black	1200	600	93	783	2672	£255.00
PHG120-60ZCA	Cappuccino	1200	600	93	783	2672	£255.00
PHG120-60ZEX	Espresso	1200	600	93	783	2672	£255.00
PHG120-60ZMB	Matt Black	1200	600	93	783	2672	£255.00
PHG120-60ZGS	Grey Sparkle	1200	600	93	783	2672	£255.00
PHG120-60ZWS	White Sparkle	1200	600	93	783	2672	£255.00
 PHG120-60ZMGN	Moss Green	1200	600	93	783	2672	£255.00
 PHG120-60ZSBLU	Steel Blue	1200	600	93	783	2672	£255.00

1500 x 500mm Straight Towel Rail

		Height	Width	Depth	Watts	Btu/hr	
PHG150-50ZAT	Anthracite	1500	500	93	783	2798	£292.00
PHG150-50ZSB	Satin Black	1500	500	93	783	2798	£292.00
PHG150-50ZCA	Cappuccino	1500	500	93	783	2798	£292.00
PHG150-50ZEX	Espresso	1500	500	93	783	2798	£292.00
PHG150-50ZMB	Matt Black	1500	500	93	783	2798	£292.00
PHG150-50ZGS	Grey Sparkle	1500	500	93	783	2798	£292.00
PHG150-50ZWS	White Sparkle	1500	500	93	783	2798	£292.00
 PHG150-50ZMGN	Moss Green	1500	500	93	783	2798	£292.00
 PHG150-50ZSBLU	Steel Blue	1500	500	93	783	2798	£292.00

1800 x 500mm Straight Towel Rail

		Height	Width	Depth	Watts	Btu/hr	
PHG180-50ZAT	Anthracite	1800	500	93	969	3306	£322.00
PHG180-50ZSB	Satin Black	1800	500	93	969	3306	£322.00
PHG180-50ZCA	Cappuccino	1800	500	93	969	3306	£322.00
PHG180-50ZEX	Espresso	1800	500	93	969	3306	£322.00
PHG180-50ZMB	Matt Black	1800	500	93	969	3306	£322.00
PHG180-50ZGS	Grey Sparkle	1800	500	93	969	3306	£322.00
PHG180-50ZWS	White Sparkle	1800	500	93	969	3306	£322.00
 PHG180-50ZMGN	Moss Green	1800	500	93	969	3306	£322.00
 PHG180-50ZSBLU	Steel Blue	1800	500	93	969	3306	£322.00

25mm Towel Rails

Guarantees

15 Years
on Towel Rails

Please see pages 392-393 for our range of valves

Straight Towel Rails



Chrome



White

Chrome Finish

Material – Mild Steel

All heat outputs are shown at 50°C Δt in compliance with BSEN442

Rear air vent

MS

	Height	Width	Depth	Watts	Btu/hr	Electric Element	
PHG080-30CP	800	300	93-113	177	604	100	£198.00
PHG080-40CP	800	400	93-113	226	771	125	£206.00
PHG080-50CP	800	500	93-113	275	938	150	£225.00
PHG080-60CP	800	600	93-113	324	1105	200	£248.00
PHG100-50CP	1000	500	93-113	351	1198	200	£262.00
PHG100-60CP	1000	600	93-113	414	1413	200	£271.00
PHG120-30CP	1200	300	93-113	273	931	200	£284.00
PHG120-40CP	1200	400	93-113	350	1194	200	£290.00
PHG120-50CP	1200	500	93-113	428	1460	300	£301.00
PHG120-60CP	1200	600	93-113	505	1723	400	£310.00
PHG150-50CP	1500	500	93-113	534	1822	300	£399.00
PHG150-60CP	1500	600	93-113	631	2153	400	£445.00
PHG180-40CP	1800	400	93-113	521	1778	400	£456.00
PHG180-50CP	1800	500	93-113	638	2177	600	£491.00
PHG180-60CP	1800	600	93-113	754	2573	600	£547.00

White Finish

Material – Mild Steel

All heat outputs are shown at 50°C Δt in compliance with BSEN442

Rear air vent

MS

	Height	Width	Depth	Watts	Btu/hr	Electric Element	
PHG080-30WH	800	300	93-113	271	925	100	£114.00
PHG080-40WH	800	400	93-113	346	1181	125	£123.00
PHG080-50WH	800	500	93-113	420	1433	150	£131.00
PHG080-60WH	800	600	93-113	495	1689	200	£146.00
PHG100-50WH	1000	500	93-113	446	1522	200	£162.00
PHG100-60WH	1000	600	93-113	510	1742	200	£175.00
PHG120-30WH	1200	300	93-113	424	1447	200	£154.00
PHG120-40WH	1200	400	93-113	543	1853	200	£162.00
PHG120-50WH	1200	500	93-113	663	2262	300	£173.00
PHG120-60WH	1200	600	93-113	783	2672	400	£181.00
PHG150-50WH	1500	500	93-113	820	2798	300	£191.00
PHG150-60WH	1500	600	93-113	969	3306	400	£205.00
PHG180-40WH	1800	400	93-113	793	2706	400	£220.00
PHG180-50WH	1800	500	93-113	969	3306	600	£235.00
PHG180-60WH	1800	600	93-113	1146	3910	600	£248.00

Heating option supplement applies across all 25mm Straight + 25mm Curved

PHGT25-HE-SUPP	Dual fuel add on cost	£189.00
PHGT25-EO-SUPP	Sealed Electric add on cost	£275.00

25mm Towel Rails

Curved Towel Rails



Chrome Finish

Material – Mild Steel
 All heat outputs are shown at 50°C Δt in compliance with BSEN442
 Rear air vent



White Finish

Material – Mild Steel
 All heat outputs are shown at 50°C Δt in compliance with BSEN442
 Rear air vent



	Height	Width	Depth	Watts	Btu/hr	Electric Element	
PHG080-50CPCV	800	500	88-108	275	938	150	£187.00
PHG080-60CPCV	800	600	94-114	324	1105	200	£202.00
PHG100-50CPCV	1000	500	88-108	351	1198	200	£217.00
PHG100-60CPCV	1000	600	94-114	414	1413	200	£231.00
PHG120-50CPCV	1200	500	88-108	428	1460	300	£262.00
PHG120-60CPCV	1200	600	94-114	505	1723	400	£275.00
PHG150-50CPCV	1500	500	88-108	534	1822	300	£335.00
PHG150-60CPCV	1500	600	94-114	631	2153	400	£365.00
PHG180-50CPCV	1800	500	88-108	638	2177	600	£423.00
PHG180-60CPCV	1800	600	94-114	754	2573	600	£453.00

	Height	Width	Depth	Watts	Btu/hr	Electric Element	
PHG080-50WHCV	800	500	88-108	420	1433	150	£146.00
PHG080-60WHCV	800	600	94-114	495	1689	200	£162.00
PHG120-50WHCV	1200	500	88-108	663	2262	300	£187.00
PHG120-60WHCV	1200	600	94-114	783	2672	400	£196.00
PHG150-50WHCV	1500	500	88-108	820	2798	300	£205.00
PHG150-60WHCV	1500	600	94-114	969	3306	400	£220.00
PHG180-50WHCV	1800	500	88-108	969	3306	600	£248.00
PHG180-60WHCV	1800	600	94-114	1146	3910	600	£264.00

25mm Towel Rails

Please see pages 392-393 for our range of valves

Guarantees

15 Years
on Towel Rails

Horizontal Straight Towel Rails



Chrome

Chrome Finish (Heating Only)

Material – Mild Steel

All heat outputs are shown at 50°C Δt in compliance with BSEN442

Rear air vent

MS

	Height	Width	Depth	Bars	Pipe Centres	Watts	Btu/hr	
PHG-H04010CP	400	1000	93-113	3-4	955	200	682	£165.00
PHG-H05010CP	500	1000	93-113	3-6	955	256	873	£191.00
PHG-H06010CP	600	1000	93-113	3-3-4	955	288	983	£205.00

Anthracite Finish (Heating Only)

Material – Mild Steel

All heat outputs are shown at 50°C Δt in compliance with BSEN442

Rear air vent

MS

	Height	Width	Depth	Bars	Pipe Centres	Watts	Btu/hr	
PHG-H04010AT	400	1000	93-113	3-4	955	302	1030	£121.00
PHG-H05010AT	500	1000	93-113	3-6	955	386	1317	£141.00
PHG-H06010AT	600	1000	93-113	3-3-4	955	434	1481	£159.00

Heating option supplement applies across all 25mm Straight + 25mm Curved

PHGT25-HE-SUPP	Dual fuel add on cost	£189.00
PHGT25-EO-SUPP	Sealed Electric add on cost	£275.00

25mm Towel Rails

Straight Towel Rails (Sealed Electric)



Chrome

Chrome Finish (Sealed Electric)

Material – Mild Steel
2 year guarantee on the element



	Height	Width	Depth	Bars	Electric Element	
PHG080-50CP-E	800	500	93-113	3-5-6	150	£367.00
PHG080-60CP-E	800	600	93-113	3-5-6	200	£396.00

	Height	Width	Depth	Bars	Electric Element	
PHG120-50CP-E	1200	500	93-113	4-5-13	300	£488.00
PHG120-60CP-E	1200	600	93-113	4-5-13	400	£523.00

Coloured Valves + Elements

Coloured Valves



Brushed Brass
INCNT003AP-ZBBS



Gunmetal
INCNT003AP-ZGM



Satin Brushed Nickel
INCNT003AP-ZBN



Moss Green
INCNT003AP-ZMGN



Steel Blue
INCNT003AP-ZSBLU



Anthracite
INCNT003AP-ZAT



White Sparkle
INCNT003AP-ZWS



Satin Black
INCNT003AP-ZSB

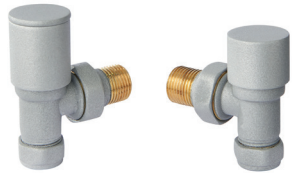

Grey Sparkle
INCNT003AP-ZGS



Matt Black
INCNT003AP-ZMB



Cappuccino
INCNT003AP-ZCA



Espresso
INCNT003AP-ZEX

Straight Valves (1/2" x 15mm)

new	INCNT003ST-ZBBS	Brushed Brass	£47.00
new	INCNT003ST-ZGM	Gunmetal	£47.00
new	INCNT003ST-ZBN	Satin Brushed Nickel	£47.00
new	INCNT003ST-ZMGN	Moss Green	£47.00
new	INCNT003ST-ZSBLU	Steel Blue	£47.00
	INCNT003ST-ZAT	Anthracite	£47.00
	INCNT003ST-ZWS	White Sparkle	£47.00
	INCNT003ST-ZSB	Satin Black	£47.00
	INCNT003ST-ZGS	Grey Sparkle	£47.00
	INCNT003ST-ZMB	Matt Black	£47.00
	INCNT003ST-ZCA	Cappuccino	£47.00
	INCNT003ST-ZEX	Espresso	£47.00

Angled Valves (1/2" x 15mm)

new	INCNT003AP-ZBBS	Brushed Brass	£47.00
new	INCNT003AP-ZGM	Gunmetal	£47.00
new	INCNT003AP-ZBN	Satin Brushed Nickel	£47.00
new	INCNT003AP-ZMGN	Moss Green	£47.00
new	INCNT003AP-ZSBLU	Steel Blue	£47.00
	INCNT003AP-ZAT	Anthracite	£47.00
	INCNT003AP-ZWS	White Sparkle	£47.00
	INCNT003AP-ZSB	Satin Black	£47.00
	INCNT003AP-ZGS	Grey Sparkle	£47.00
	INCNT003AP-ZMB	Matt Black	£47.00
	INCNT003AP-ZCA	Cappuccino	£47.00
	INCNT003AP-ZEX	Espresso	£47.00



Brushed Brass
INCNT023-BBS



Gunmetal
INCNT023-GM



Brushed Nickel
INCNT023-BN



Moss Green
INCNT023-MGN



Steel Blue
INCNT023-SBLU



Anthracite
INCNT023-AT



White Sparkle
INCNT023-WWS



Satin Black
INCNT023-SB



Grey Sparkle
INCNT023-GS



Matt Black
INCNT023-MB



Cappuccino
INCNT023-CA



Espresso
INCNT023-EX

Corner Valves (1/2" x 15mm)

new	INCNT023-BBS	Brushed Brass	£58.00
new	INCNT023-GM	Gunmetal	£58.00
new	INCNT023-BN	Brushed Nickel	£58.00
new	INCNT023-MGN	Moss Green	£49.00
new	INCNT023-SBLU	Steel Blue	£49.00
new	INCNT023-AT	Anthracite	£49.00

Corner Valves (1/2" x 15mm)

new	INCNT023-WWS	White Sparkle	£49.00
new	INCNT023-SB	Satin Black	£49.00
new	INCNT023-GS	Grey Sparkle	£49.00
new	INCNT023-MB	Matt Black	£49.00
new	INCNT023-CA	Cappuccino	£49.00
new	INCNT023-EX	Espresso	£49.00

Coloured Valves + Elements

15mm Pipe Connection Tubes (Pair)



Anthracite
INCNT005-AT

Matt Black
INCNT005-MB

White Sparkle
INCNT005-WS

Grey Sparkle
INCNT005-GS

Cappuccino
INCNT005-CA

Espresso
INCNT005-EX

Steel Blue
INCNT005-SBLU

Moss Green
INCNT005-ZMGN

new INCNT005-AT	Anthracite	£36.00
new INCNT005-MB	Matt Black	£36.00
new INCNT005-WS	White Sparkle	£36.00
new INCNT005-GS	Grey Sparkle	£36.00

new INCNT005-CA	Cappuccino	£36.00
new INCNT005-EX	Espresso	£36.00
new INCNT005-SBLU	Steel Blue	£36.00
new INCNT005-MGN	Moss Green	£36.00

Elements



Standard Element IP55

A benchmark element to suit each size of product.

PHG-EOST	Electric Only	£275.00
PHG-DFST	Dual Fuel	£189.00



15mm Dual Fuel Corner Radiator Valves (Pair)

Finish – Polished Chrome
Dimensions – 71.8(h) x 64.3(w) x 68.5/48.3(d) mm

INST-AL049LC	£67.00
---------------------	--------

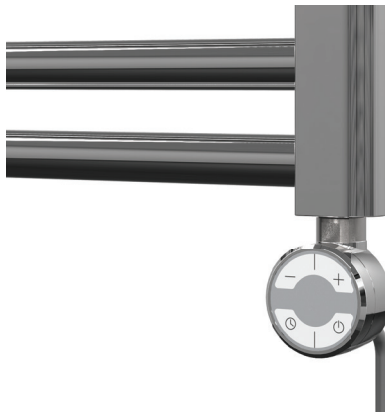

Heat Sensor Element IPX5*

An electronic temperature sensor control.

PHG-EOHS	Electric Only	£412.00
PHG-DFHS	Dual Fuel	£340.00

*Optional cover shroud available PHG-AC040, ask for details.

Towel Rail Element including Tee Piece + 1/2" Plug

Suitable for both dual-fuel and electric only
Maintains liquid temperature between 40-54°C

TRE150	150W	£67.00
TRE250	250W	£67.00
TRE400	400W	£71.00
TRE600	600W	£71.00
TRE800	800W	£75.00

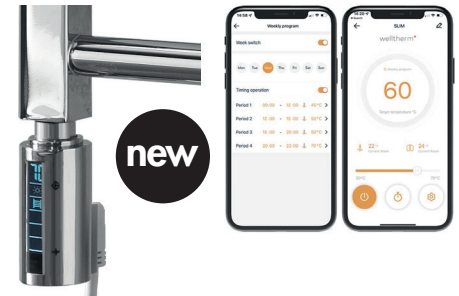

Remote Controlled Heat Element IPX4 NTC – Negative Temperature Coefficient Technology

Remote controlled programmable element for adjustable temperature control via App or remote control (see below).

SEE005-0300CP	NTC IPX4 300W	£305.00
SEE005-0600CP	NTC IPX4 600W	£315.00

Remote Control

Remote control for heat element IPX4 NTC.



SEE005-REMOTE	£80.00
----------------------	--------

1/2" M + F Dual Fuel Elbow

Finish – Chrome



DFE12	£11.00
--------------	--------

Azerley

Guarantees

30 Years on Azerley **15** Years on Broxa

new



Matt Black

Azerley

Finish – Matt White, Matt Black or Anthracite
Material – Aluminium

All heat outputs are shown at 50°C Δt in compliance with BSEN442.

For details on up-grading from standard elements to Thermostatic or Remote Control, please see page 363.

AL

Matt White Finish							Heating Only	Dual Fuel	Electric Only	
Height	Width	Depth	Bars	Pipe Centres	Watts	Btu/hr				
700	500	72-81	3	470	329	1123	AZ0700500MW	£380.00	AZ0700500MW-HE £469.00	AZ0700500MW-E £580.00
1000	500	72-81	4	470	446	1522	AZ1000500MW	£475.00	AZ0700500MW-HE £565.00	AZ1000500MW-E £676.00
1300	500	72-81	5	470	563	1921	AZ1300500MW	£583.00	AZ1300500MW-HE £672.00	AZ1300500MW-E £783.00
1500	500	72-81	6	470	681	2324	AZ1600500MW	£674.00	AZ1600500MW-HE £763.00	AZ1600500MW-E £875.00

Matt Black Finish							Heating Only	Dual Fuel	Electric Only	
Height	Width	Depth	Bars	Pipe Centres	Watts	Btu/hr				
700	500	72-81	3	470	329	1123	AZ0700500MB	£388.00	AZ0700500MB-HE £477.00	AZ0700500MB-E £588.00
1000	500	72-81	4	470	446	1522	AZ1000500MB	£486.00	AZ1000500MB-HE £575.00	AZ1000500MB-E £687.00
1300	500	72-81	5	470	563	1921	AZ1300500MB	£597.00	AZ1300500MB-HE £686.00	AZ1300500MB-E £798.00
1500	500	72-81	6	470	681	2324	AZ1600500MB	£691.00	AZ1600500MB-HE £756.00	AZ1600500MB-E £892.00

Anthracite Finish							Heating Only	Dual Fuel	Electric Only	
Height	Width	Depth	Bars	Pipe Centres	Watts	Btu/hr				
700	500	72-81	3	470	329	1123	AZ0700500AT	£393.00	AZ0700500AT-HE £482.00	AZ0700500AT-E £594.00
1000	500	72-81	4	470	446	1522	AZ1000500AT	£493.00	AZ1000500AT-HE £583.00	AZ1000500AT-E £694.00
1300	500	72-81	5	470	563	1921	AZ1300500AT	£606.00	AZ1300500AT-HE £695.00	AZ1300500AT-E £807.00
1500	500	72-81	6	470	681	2324	AZ1600500AT	£702.00	AZ1600500AT-HE £791.00	AZ1600500AT-E £903.00

Please see pages 392-393 for our range of valves

Broxa

new



Brushed Brass

Broxa

Finish – Brushed Brass

Material – Mild Steel

All heat outputs are shown at 50°C Δt in compliance with BSEN442. Watts & Btu's apply to Heating & Dual Fuel only.

For details on up-grading from standard elements to Thermostatic or Remote Control, please see page 363.

MS

							Heating Only	Dual Fuel		Electric Only		
Height	Width	Depth	Bars	Pipe Centres	Watts	Btu/hr						
1200	500	102	3-4-5	450	437	1491	BR12050BR	£642.00	BR12050BR-HE	£747.00	BR12050BR-E	£879.00

Kiso

Guarantees

30 Years
on Kiso, Kilpin + Tone



Kiso

Finish – Polished Stainless Steel Material – Stainless Steel

All heat outputs are shown at 50°C Δt in compliance with BSEN442. Watts & Btu's apply to Heating & Dual Fuel only. For details on up-grading from standard elements to Thermostatic or Remote Control, please see page 363.



Straight							Heating Only		Dual Fuel		Electric Only	
Height	Width	Depth	Bars	Pipe Centres	Watts	Btu/hr						
800	300	100	3-4-5	268	161	549	KI-S0830S	£440.00	KI-S0830S-HE	£619.00	KI-S0830S-E	£700.00
800	400	100	3-4-5	368	197	672	KI-S0840S	£467.00	KI-S0840S-HE	£645.00	KI-S0840S-E	£725.00
800	500	100	3-4-5	468	243	829	KI-S0850S	£508.00	KI-S0850S-HE	£686.00	KI-S0850S-E	£768.00
800	600	100	3-4-5	568	269	918	KI-S0860S	£590.00	KI-S0860S-HE	£766.00	KI-S0860S-E	£849.00
1200	300	100	3-4-5-6	268	240	819	KI-S1230S	£645.00	KI-S1230S-HE	£823.00	KI-S1230S-E	£904.00
1200	400	100	3-4-5-6	368	294	1003	KI-S1240S	£678.00	KI-S1240S-HE	£856.00	KI-S1240S-E	£937.00
1200	500	100	3-4-5-6	468	348	1187	KI-S1250S	£732.00	KI-S1250S-HE	£909.00	KI-S1250S-E	£990.00
1200	600	100	3-4-5-6	568	402	1372	KI-S1260S	£856.00	KI-S1260S-HE	£1033.00	KI-S1260S-E	£1115.00
1600	300	100	3-4-5-6-6	268	321	1095	KI-S1630S	£915.00	KI-S1630S-HE	£1092.00	KI-S1630S-E	£1174.00
1600	400	100	3-4-5-6-6	368	391	1334	KI-S1640S	£1039.00	KI-S1640S-HE	£1213.00	KI-S1640S-E	£1294.00
1600	500	100	3-4-5-6-6	468	464	1583	KI-S1650S	£1129.00	KI-S1650S-HE	£1306.00	KI-S1650S-E	£1389.00
1600	600	100	3-4-5-6-6	568	536	1829	KI-S1660S	£1243.00	KI-S1660S-HE	£1419.00	KI-S1660S-E	£1502.00

Curved							Heating Only		Dual Fuel		Electric Only	
Height	Width	Depth	Bars	Pipe Centres	Watts	Btu/hr						
800	500	120	3-4-5	468	243	829	KI-C0850S	£591.00	KI-C0850S-HE	£769.00	KI-C0850S-E	£850.00
800	600	130	3-4-5	568	269	918	KI-C0860S	£671.00	KI-C0860S-HE	£850.00	KI-C0860S-E	£930.00
1200	500	120	3-4-5-6	468	348	1187	KI-C1250S	£828.00	KI-C1250S-HE	£1006.00	KI-C1250S-E	£1087.00
1200	600	130	3-4-5-6	568	402	1372	KI-C1260S	£951.00	KI-C1260S-HE	£1129.00	KI-C1260S-E	£1210.00
1600	500	120	3-4-5-6-6	468	464	1583	KI-C1650S	£1153.00	KI-C1650S-HE	£1330.00	KI-C1650S-E	£1411.00
1600	600	130	3-4-5-6-6	568	536	1829	KI-C1660S	£1264.00	KI-C1660S-HE	£1443.00	KI-C1660S-E	£1524.00

Please see pages 392-393 for our range of valves

Kilpin / Tone



Kilpin

Finish – Polished Stainless Steel

Material – Stainless Steel

All heat outputs are shown at 50°C Δt in compliance with BSEN442.

For details on up-grading from standard elements to Thermostatic or Remote Control, please see page 363.



Heating Only

	Height	Width	Depth	Bars	Pipe Centres	Watts	Btu/hr	
KILPIN0700500PS	700	500	100	3	468	86	293	£425.00
KILPIN1200500PS	1200	500	100	5	468	217	740	£658.00
KILPIN1600500PS	1600	500	100	7	468	296	1010	£845.00

Dual Fuel

	Height	Width	Depth	Bars	Pipe Centres	Watts	Btu/hr	
KILPIN0700500PS-HE	700	500	100	3	468	86	293	£607.00
KILPIN1200500PS-HE	1200	500	100	5	468	217	740	£841.00
KILPIN1600500PS-HE	1600	500	100	7	468	296	1010	£1028.00

Electric Only

	Height	Width	Depth	Bars	Pipe Centres	Watts	Btu/hr	
KILPIN0700500PS-E	700	500	100	3	468	293	-	£690.00
KILPIN1200500PS-E	1200	500	100	5	468	740	-	£923.00
KILPIN1600500PS-E	1600	500	100	7	468	1010	-	£1111.00



Tone

Finish – Polished Stainless Steel

Material – Stainless Steel

All heat outputs are shown at 50°C Δt in compliance with BSEN442.

For details on up-grading from standard elements to Thermostatic or Remote Control, please see page 363.



Heating Only

	Height	Width	Depth	Bars	Pipe Centres	Watts	Btu/hr	
TO0600750PS	600	750	100	4-5	718	419	1430	£619.00
TO0601000PS	600	1000	100	4-5	968	517	1764	£712.00
TO0800750PS	800	750	100	3-4-5	718	529	1805	£752.00
TO0801000PS	800	1000	100	3-4-5	968	682	2327	£819.00

Dual Fuel

	Height	Width	Depth	Bars	Pipe Centres	Watts	Btu/hr	
TO0600750PS-HE	600	750	100	4-5	718	419	1430	£831.00
TO0601000PS-HE	600	1000	100	4-5	968	517	1764	£927.00
TO0800750PS-HE	800	750	100	3-4-5	718	529	1805	£963.00
TO0801000PS-HE	800	1000	100	3-4-5	968	682	2327	£1033.00

Electric Only

	Height	Width	Depth	Bars	Pipe Centres	Watts	Btu/hr	
TO0600750PS-E	600	750	100	4-5	718	100	-	£930.00
TO0601000PS-E	600	1000	100	4-5	968	125	-	£1022.00
TO0800750PS-E	800	750	100	3-4-5	718	125	-	£1062.00
TO0801000PS-E	800	1000	100	3-4-5	968	150	-	£1133.00

Brierley / Voil

Guarantees

15 Years
on Brierley, Voil + Shauna



Chrome

Brierley

Finish – Chrome

Material – Mild Steel

All heat outputs are shown at 50°C Δt in compliance with BSEN442.

For details on up-grading from standard elements to Thermostatic or Remote Control, please see page 363.

MS

Heating Only

	Height	Width	Depth	Bars	Pipe Centres	Watts	Btu/hr	
BRIERL1200500CP	1200	500	125-137	9	80	237	809	£643.00
BRIERL1500500CP	1500	500	125-137	9	80	309	1054	£732.00

Dual Fuel

	Height	Width	Depth	Bars	Pipe Centres	Watts	Btu/hr	
BRIERL1200500CP-HE	1200	500	125-137	9	80	237	809	£874.00
BRIERL1500500CP-HE	1500	500	125-137	9	80	309	1054	£962.00

Electric Only

	Height	Width	Depth	Bars	Pipe Centres	Watts	Btu/hr	
BRIERL1200500CP-E	1200	500	125-137	9	80	200	-	£977.00
BRIERL1500500CP-E	1500	500	125-137	9	80	400	-	£1066.00



Anthracite

Voil

Finish – Anthracite

Material – Mild Steel

All heat outputs are shown at 50°C Δt in compliance with BSEN442.

Watts & Btu's apply to Heating & Dual Fuel only.

For details on up-grading from standard elements to Thermostatic or Remote Control, please see page 363.

MS

Heating Only

	Height	Width	Depth	Bars	Pipe Centres	Watts	Btu/hr	
VOIL0850500AT	850	500	125	8	300	524	1788	£425.00
VOIL1200500AT	1200	500	125	8	300	683	2330	£553.00
VOIL1550500AT	1550	500	125	8	300	966	3296	£729.00

Dual Fuel

	Height	Width	Depth	Bars	Pipe Centres	Watts	Btu/hr	
VOIL0850500AT-HE	850	500	125	8	300	524	1788	£631.00
VOIL1200500AT-HE	1200	500	125	8	300	683	2330	£758.00
VOIL1550500AT-HE	1550	500	125	8	300	966	3296	£934.00

Electric Only

	Height	Width	Depth	Bars	Pipe Centres	Watts	Btu/hr	
VOIL0850500AT-E	850	500	125	8	300	524	1788	£723.00
VOIL1200500AT-E	1200	500	125	8	300	683	2330	£852.00
VOIL1550500AT-E	1550	500	125	8	300	966	3296	£1028.00

Please see pages 392-393 for our range of valves

Shauna



Matt Black

Shauna

Finish – Matt Black or White Sparkle

Material – Mild Steel

All heat outputs are shown at 50°C Δt in compliance with BSEN442.

For details on up-grading from standard elements to Thermostatic or Remote Control, please see page 363.

MS

Matt Black Finish – Heating Only

	Height	Width	Depth	Pipe Centres	Watts	Btu/hr	
SHAUNA0800500MB	800	500	105-120	50	447	1525	£482.00
SHAUNA1200500MB	1200	500	105-120	50	628	2143	£600.00
SHAUNA1500500MB	1500	500	105-120	50	770	2627	£682.00

Matt Black Finish – Dual Fuel

	Height	Width	Depth	Pipe Centres	Watts	Btu/hr	
SHAUNA0800500MB-HE	800	500	105-120	50	447	1525	£690.00
SHAUNA1200500MB-HE	1200	500	105-120	50	628	2143	£808.00
SHAUNA1500500MB-HE	1500	500	105-120	50	770	2627	£889.00

Matt Black Finish – Electric Only

	Height	Width	Depth	Pipe Centres	Watts	Btu/hr	
SHAUNA0800500MB-E	800	500	105-120	50	300	-	£783.00
SHAUNA1200500MB-E	1200	500	105-120	50	400	-	£900.00
SHAUNA1500500MB-E	1500	500	105-120	50	600	-	£982.00

White Sparkle Finish – Heating Only

	Height	Width	Depth	Pipe Centres	Watts	Btu/hr	
SHAUNA0800500WS	800	500	105-120	50	447	1525	£482.00
SHAUNA1200500WS	1200	500	105-120	50	628	2143	£600.00
SHAUNA1500500WS	1500	500	105-120	50	770	2627	£682.00

White Sparkle Finish – Dual Fuel

	Height	Width	Depth	Pipe Centres	Watts	Btu/hr	
SHAUNA0800500WS-HE	800	500	105-120	50	447	1525	£690.00
SHAUNA1200500WS-HE	1200	500	105-120	50	628	2143	£808.00
SHAUNA1500500WS-HE	1500	500	105-120	50	770	2627	£889.00

White Sparkle Finish – Electric Only

	Height	Width	Depth	Pipe Centres	Watts	Btu/hr	
SHAUNA0800500WS-E	800	500	105-120	50	300	-	£783.00
SHAUNA1200500WS-E	1200	500	105-120	50	400	-	£900.00
SHAUNA1500500WS-E	1500	500	105-120	50	600	-	£982.00

Crambeck

Guarantees

15 Years
on Crambeck + Muse



Chrome



Matt Black

Crambeck

Finish – Chrome or Matt Black

Material – Mild Steel

All heat outputs are shown at 50°C Δt in compliance with BSEN442.

For details on up-grading from standard elements to Thermostatic or Remote Control, please see page 363.

MS

Chrome Finish – Heating Only

	Height	Width	Depth	Pipe Centres	Watts	Btu/hr	
CRAMBECK08050CP	828	500	95	430	232	792	£467.00
CRAMBECK12050CP	1200	500	95	430	346	1181	£600.00
CRAMBECK18050CP	1800	500	95	430	491	1675	£753.00

Chrome Finish – Dual Fuel

	Height	Width	Depth	Pipe Centres	Watts	Btu/hr	
CRAMBECK08050CP-HE	828	500	95	430	232	792	£649.00
CRAMBECK12050CP-HE	1200	500	95	430	346	1181	£783.00
CRAMBECK18050CP-HE	1800	500	95	430	491	1675	£935.00

Chrome Finish – Electric Only

	Height	Width	Depth	Pipe Centres	Watts	Btu/hr	
CRAMBECK08050CP-E	828	500	95	430	232	-	£732.00
CRAMBECK12050CP-E	1200	500	95	430	346	-	£865.00
CRAMBECK18050CP-E	1800	500	95	430	491	-	£1019.00

Matt Black Finish – Heating Only

	Height	Width	Depth	Pipe Centres	Watts	Btu/hr	
CRAMBECK08050MB	828	500	95	430	290	989	£447.00
CRAMBECK12050MB	1200	500	95	430	432	1474	£560.00
CRAMBECK18050MB	1800	500	95	430	614	2095	£728.00

Matt Black Finish – Dual Fuel

	Height	Width	Depth	Pipe Centres	Watts	Btu/hr	
CRAMBECK08050MB-HE	828	500	95	430	290	989	£549.00
CRAMBECK12050MB-HE	1200	500	95	430	432	1474	£668.00
CRAMBECK18050MB-HE	1800	500	95	430	614	2095	£815.00

Matt Black Finish – Electric Only

	Height	Width	Depth	Pipe Centres	Watts	Btu/hr	
CRAMBECK08050MB-E	828	500	95	430	290	-	£682.00
CRAMBECK12050MB-E	1200	500	95	430	432	-	£800.00
CRAMBECK18050MB-E	1800	500	95	430	614	-	£949.00

Muse

Please see pages 392-393 for our range of valves



Muse

Finish – Chrome or Matt Black

Material – Mild Steel

All heat outputs are shown at 50°C Δt in compliance with BSEN442.

For details on up-grading from standard elements to Thermostatic or Remote Control, please see page 363.

MS

Chrome Finish – Heating Only

	Height	Width	Depth	Bars	Pipe Centres	Watts	Btu/hr	
MU1200500CP	1200	500	118	3-3-3-3-3	60	354	1208	£640.00
MU1400600CP	1400	600	118	3-3-3-3-3	60	436	1488	£704.00

Chrome Finish – Dual Fuel

	Height	Width	Depth	Bars	Pipe Centres	Watts	Btu/hr	
MU1200500CP-HE	1200	500	118	3-3-3-3-3	60	354	1208	£852.00
MU1400600CP-HE	1400	600	118	3-3-3-3-3	60	436	1488	£918.00

Chrome Finish – Electric Only

	Height	Width	Depth	Bars	Pipe Centres	Watts	Btu/hr	
MU1200500CP-E	1200	500	118	3-3-3-3-3	60	150	–	£950.00
MU1400600CP-E	1400	600	118	3-3-3-3-3	60	200	–	£1017.00

Matt Black Finish – Heating Only

	Height	Width	Depth	Bars	Pipe Centres	Watts	Btu/hr	
new MU1200500MB	1200	500	118	3-3-3-3-3	60	442	1508	£594.00
new MU1400600MB	1400	600	118	3-3-3-3-3	60	545	1859	£666.00

Matt Black Finish – Dual Fuel

	Height	Width	Depth	Bars	Pipe Centres	Watts	Btu/hr	
new MU1200500MB-HE	1200	500	118	3-3-3-3-3	60	442	1508	£703.00
new MU1400600MB-HE	1400	600	118	3-3-3-3-3	60	545	1859	£775.00

Matt Black Finish – Electric Only

	Height	Width	Depth	Bars	Pipe Centres	Watts	Btu/hr	
new MU1200500MB-E	1200	500	118	3-3-3-3-3	60	150	–	£841.00
new MU1400600MB-E	1400	600	118	3-3-3-3-3	60	200	–	£912.00

Luna

Guarantees

30 Years on Luna **15** Years on Paros



Anthracite



White

Luna

Finish – White or Anthracite
Material – Aluminium

All heat outputs are shown at 50°C Δt in compliance with BSEN442. Watts & Btu's apply to Heating & Dual Fuel only. Watts 600 on Electric only model. For details on up-grading from standard elements to Thermostatic or Remote Control, please see pages 363.

AL

White Finish						Heating Only		Dual Fuel		Electric Only	
Height	Width	Depth	Pipe Centres	Watts	Btu/hr						
1200	500	100	470	778	2655	LUN12050WH	£546.00	LUN12050WH-HE	£777.00	LUN12050WH-E	£880.00
new 1600	500	100	-	1043	3560	LUN16050WH	£647.00	LUN16050WH-HE	£818.00	LUN16050WH-E	£895.00

Anthracite Finish						Heating Only		Dual Fuel		Electric Only	
Height	Width	Depth	Pipe Centres	Watts	Btu/hr						
1200	500	100	470	778	2655	LUN12050AT	£564.00	LUN12050AT-HE	£791.00	LUN12050AT-E	£896.00
new 1600	500	100	-	1043	3560	LUN16050AT	£664.00	LUN16050AT-HE	£835.00	LUN16050AT-E	£913.00

Please see pages 392-393 for our range of valves

Paros



Paros

Finish – Chrome
Material – Mild Steel

All heat outputs are shown at 50°C Δt in compliance with BSEN442. Watts & Btu's apply to Heating & Dual Fuel only.
For details on up-grading from standard elements to Thermostatic or Remote Control, please see page 363.

MS

Straight							Heating Only		Dual Fuel		Electric Only	
Height	Width	Depth	Bars	Pipe Centres	Watts	Btu/hr						
772	500	80-95	3-5-5	450	290	989	PA0772500CP	£303.00	PA0772500CP-HE	£517.00	PA0772500CP-E	£613.00
772	600	80-95	3-5-5	550	347	1184	PA0772600CP	£326.00	PA0772600CP-HE	£539.00	PA0772600CP-E	£636.00
1186	500	80-95	5-5-5-5	450	465	1587	PA1186500CP	£413.00	PA1186500CP-HE	£625.00	PA1186500CP-E	£723.00
1186	600	80-95	5-5-5-5	550	553	1887	PA1186600CP	£449.00	PA1186600CP-HE	£660.00	PA1186600CP-E	£758.00
1508	500	80-95	5-5-5-5-5	450	581	1982	PA1508500CP	£495.00	PA1508500CP-HE	£711.00	PA1508500CP-E	£808.00
1508	600	80-95	5-5-5-5-5	550	686	2341	PA1508600CP	£541.00	PA1508600CP-HE	£755.00	PA1508600CP-E	£851.00
1738	500	80-95	6-6-6-6-6	450	687	2344	PA1738500CP	£568.00	PA1738500CP-HE	£781.00	PA1738500CP-E	£878.00
1738	600	80-95	6-6-6-6-6	550	815	2781	PA1738600CP	£618.00	PA1738600CP-HE	£831.00	PA1738600CP-E	£930.00

Curved							Heating Only		Dual Fuel		Electric Only	
Height	Width	Depth	Bars	Pipe Centres	Watts	Btu/hr						
772	500	100-115	3-5-5	450	290	989	PAC0772500CP	£310.00	PAC0772500CP-HE	£522.00	PAC0772500CP-E	£623.00
772	600	100-115	3-5-5	550	347	1184	PAC0772600CP	£330.00	PAC0772600CP-HE	£545.00	PAC0772600CP-E	£643.00
1186	500	100-115	5-5-5-5	450	465	1587	PAC1186500CP	£420.00	PAC1186500CP-HE	£633.00	PAC1186500CP-E	£730.00
1186	600	100-115	5-5-5-5	550	553	1887	PAC1186600CP	£491.00	PAC1186600CP-HE	£702.00	PAC1186600CP-E	£802.00
1508	500	100-115	5-5-5-5-5	450	581	1982	PAC1508500CP	£508.00	PAC1508500CP-HE	£722.00	PAC1508500CP-E	£818.00
1508	600	100-115	5-5-5-5-5	550	686	2341	PAC1508600CP	£552.00	PAC1508600CP-HE	£764.00	PAC1508600CP-E	£863.00
1738	500	100-115	6-6-6-6-6	450	687	2341	PAC1738500CP	£579.00	PAC1738500CP-HE	£791.00	PAC1738500CP-E	£888.00
1738	600	100-115	6-6-6-6-6	550	815	2781	PAC1738600CP	£633.00	PAC1738600CP-HE	£844.00	PAC1738600CP-E	£908.00

Ecstasy

Guarantees

15 Years
on Ecstasy + Nuance

new



Matt Black



Chrome

Ecstasy

Finish – Chrome or Matt Black

Material – Mild Steel

All heat outputs are shown at 50°C Δt in compliance with BSEN442. Watts & Btu's apply to Heating & Dual Fuel only.

For details on up-grading from standard elements to Thermostatic or Remote Control, please see page 363.

MS

Chrome Finish								Heating Only		Dual Fuel		Electric Only	
Height	Width	Depth	Bars	Pipe Centres	Watts	Btu/hr							
950	500	101	2-3-4	462	246	839	EC0950C	£512.00	EC0950C-HE	£690.00	EC0950C-E	£772.00	
1300	500	101	3-5-5	462	330	1126	EC1350C	£818.00	EC1350C-HE	£996.00	EC1350C-E	£1078.00	

Matt Black Finish								Heating Only		Dual Fuel		Electric Only	
Height	Width	Depth	Bars	Pipe Centres	Watts	Btu/hr							
950	500	101	2-3-4	462	289	986	new EC0950500MB	£306.00	new EC0950500MB-HE	£400.00	new EC0950500MB-E	£513.00	
1300	500	101	3-5-5	462	389	1327	new EC1300500MB	£458.00	new EC1300500MB-HE	£553.00	new EC1300500MB-E	£671.00	

Nuance

Please see pages 392-393 for our range of valves



Nuance

Finish – Chrome or Matt Black

Material – Mild Steel

All heat outputs are shown at 50°C Δt in compliance with BSEN442. Watts & Btu's apply to Heating & Dual Fuel only.

For details on up-grading from standard elements to Thermostatic or Remote Control, please see page 363.

MS

Chrome Finish							Heating Only		Dual Fuel		Electric Only	
Height	Width	Depth	Bars	Pipe Centres	Watts	Btu/hr						
1000	500	85	12	470	257	877	NU1050C	£481.00	NU1050C-HE	£658.00	NU1050C-E	£740.00
1165	500	85	15	470	314	1071	NU1150C	£522.00	NU1150C-HE	£700.00	NU1150C-E	£783.00
1165	600	85	15	570	365	1245	NU1160C	£577.00	NU1160C-HE	£755.00	NU1160C-E	£835.00
1700	500	85	20	470	434	1481	NU1750C	£682.00	NU1750C-HE	£861.00	NU1750C-E	£942.00

Matt Black Finish							Heating Only		Dual Fuel		Electric Only	
Height	Width	Depth	Bars	Pipe Centres	Watts	Btu/hr						
1000	500	85	12	470	409	1396	new NU1000500MB	£310.00	new NU1000500MB-HE	£404.00	new NU1000500MB-E	£522.00
1165	500	85	15	470	420	1433	new NU1165500MB	£342.00	new NU1165500MB-HE	£436.00	new NU1165500MB-E	£548.00
1165	600	85	15	570	437	1491	new NU1165600MB	£374.00	new NU1165600MB-HE	£468.00	new NU1165600MB-E	£586.00
1700	500	85	20	470	501	1709	new NU1700500MB	£403.00	new NU1700500MB-HE	£497.00	new NU1700500MB-E	£615.00

Hemsworth Traditional

Guarantees

15 Years
on Hemsworth, Kensington Traditional + Kinsley



Hemsworth Traditional Eight Section HE9667C



Hemsworth Traditional Five Section HE9654C

Hemsworth Traditional

Finish – Chrome and White

Material – Mild Steel

All heat outputs are shown at 50°C Δt in compliance with BSEN442.

A column radiator for high heat output within a beautiful chrome plated frame gives a perfect combination of form and function that will grace the most elegant of traditional bathroom designs.

MS

Heating Only

	Height	Width	Depth	Face to Face	Connections	Watts	Btu/hr	
HE9654C	963	538	230	393		392	1338	£855.00
HE9667C	963	673	230	528		554	1890	£1015.00
HE9676C	963	763	230	618		653	2228	£1159.00

Dual Fuel

	Height	Width	Depth	Face to Face	Connections	Watts	Btu/hr	
HE9654C-HE	963	538	230	393		392	1338	£1086.00
HE9667C-HE	963	673	230	528		554	1890	£1245.00
HE9676C-HE	963	763	230	618		653	2228	£1389.00

Electric Only

	Height	Width	Depth	Face to Face	Connections	Watts	Btu/hr	
HE9654C-E	963	538	230	393		200	-	£1188.00
HE9667C-E	963	673	230	528		300	-	£1347.00
HE9676C-E	963	763	230	618		400	-	£1492.00



Hemsworth Traditional Ten Section HE9676C

Please see pages 392-393 for our range of valves

Kensington Traditional / Kinsley



Kensington Traditional

Finish – Chrome and White

Material – Mild Steel

All heat outputs are shown at 50°C Δt in compliance with BSEN442.

Watts & Btu's apply to Heating & Dual Fuel only.

MS



Kinsley

Finish – Chrome and White

Material – Mild Steel

All heat outputs are shown at 50°C Δt in compliance with BSEN442.

Watts & Btu's apply to Heating & Dual Fuel only.

MS

Heating Only							
	Height	Width	Depth	Face to Face Connections	Watts	Btu/hr	
KENFW150050CP	1500	500	250	355	815	2781	£1246.00

Dual Fuel							
	Height	Width	Depth	Face to Face Connections	Watts	Btu/hr	
KENFW150050CP-HE	1500	500	250	355	815	2781	£1477.00

Electric Only							
	Height	Width	Depth	Face to Face Connections	Watts	Btu/hr	
KENFW150050CP-E	1500	500	250	355	815	2781	£1578.00

Heating Only							
	Height	Width	Depth	Bars	Watts	Btu/hr	
KIN1200600CP	1200	500	93	3-3-3	834	2846	£905.00
KIN1200600CP	1200	600	93	3-3-3	1033	3525	£983.00
KIN1500500CP	1500	500	93	3-3-3-3	1145	3907	£1057.00
KIN1500600CP	1500	600	93	3-3-3-3	1438	4906	£1140.00

Dual Fuel							
	Height	Width	Depth	Bars	Watts	Btu/hr	
KIN1200500CP-HE	1200	500	93	3-3-3	834	2846	£1003.00
KIN1200600CP-HE	1200	600	93	3-3-3	1033	3525	£1080.00
KIN1500500CP-HE	1500	500	93	3-3-3-3	1145	3907	£1155.00
KIN1500600CP-HE	1500	600	93	3-3-3-3	1438	4906	£1238.00

Electric Only							
	Height	Width	Depth	Bars	Watts	Btu/hr	
KIN1200500CP-E	1200	500	93	3-3-3	-	-	£1127.00
KIN1200600CP-E	1200	600	93	3-3-3	-	-	£1204.00
KIN1500500CP-E	1500	500	93	3-3-3-3	-	-	£1278.00
KIN1500600CP-E	1500	600	93	3-3-3-3	-	-	£1360.00

Nostell

Guarantees

30 Years on Nostell

Vertical Radiators



Vertical Panel

Finish – Anthracite, Matt Black or Matt White
 Material – Aluminium
 All heat outputs are shown at 50°C Δt in compliance with BSEN442.

AL

Anthracite Finish							
	Height	Width	Depth	End to End Connections	Watts	Btu/hr	
NOS1800280AT	1800	280	118	280	1335	4555	£984.00
NOS1800400AT	1800	400	118	280	1335	4555	£1278.00
NOS1800520AT	1800	520	118	280	1335	4555	£1592.00

Matt Black Finish							
	Height	Width	Depth	End to End Connections	Watts	Btu/hr	
NOS1800280MB	1800	280	118	280	1335	4555	£952.00
NOS1800400MB	1800	400	118	400	1869	6377	£1256.00
NOS1800520MB	1800	520	118	400	1869	6377	£1564.00



Matt White Finish							
	Height	Width	Depth	End to End Connections	Watts	Btu/hr	
NOS1800280MW	1800	280	118	520	2403	8199	£928.00
NOS1800400MW	1800	400	118	520	2403	8199	£1223.00
NOS1800520MW	1800	520	118	520	2403	8199	£1522.00

Horizontal Radiators



Horizontal Panel

Finish – Anthracite, Matt Black or Matt White

Material – Aluminium

All heat outputs are shown at 50°C Δt in compliance with BSEN442.

AL

Anthracite Finish

	Height	Width	Depth	End to End Connections	Watts	Btu/hr	
NOS0600640AT	600	640	118	640	1023	3490	£870.00
NOS0600760AT	600	760	118	640	1023	3490	£1001.00
NOS06001000AT	600	1000	118	640	1023	3490	£1263.00
NOS0600124AT	600	1240	118	640	1023	3490	£1534.00
NOS0600136AT	600	1360	118	760	1209	4125	£1666.00

Matt Black Finish

	Height	Width	Depth	End to End Connections	Watts	Btu/hr	
NOS0600640MB	600	640	118	760	1209	4125	£856.00
NOS0600760MB	600	760	118	760	1209	4125	£984.00
NOS06001000MB	600	1000	118	760	1209	4125	£1242.00
NOS0600124MB	600	1240	118	1000	1581	5394	£1507.00
NOS0600124MB	600	1360	118	1000	1581	5394	£1636.00

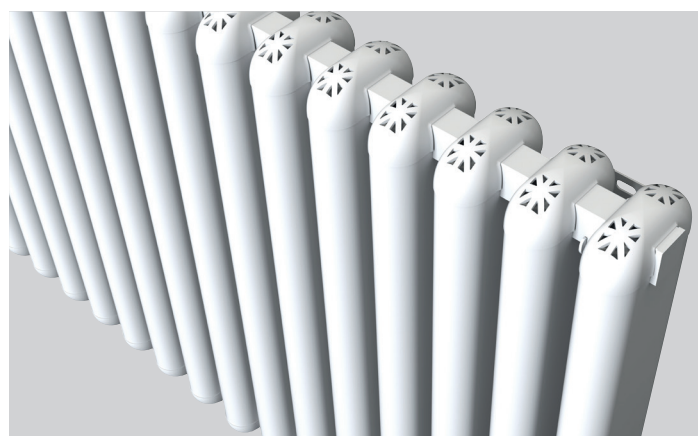

Matt White Finish

	Height	Width	Depth	End to End Connections	Watts	Btu/hr	
NOS0600640MW	600	640	118	1240	1953	6664	£834.00
NOS0600760MW	600	760	118	1360	2139	7298	£959.00
NOS06001000MW	600	1000	118	1360	2139	7298	£1209.00
NOS0600124MW	600	1240	118	1360	2139	7298	£1467.00
NOS0600136MW	600	1360	118	1360	2139	7298	£1591.00

Lissett

Guarantees

30 Years on Lissett **15** Years on Ovate Double

new



Matt Black



Matt White

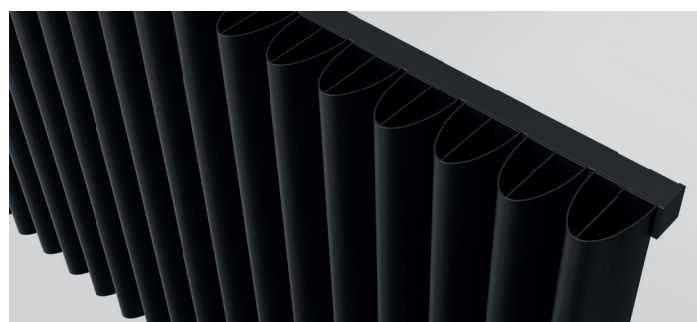

Horizontal Panel

Finish – Anthracite, Matt Black or Matt White Material – Aluminium
All heat outputs are shown at 50°C Δt in compliance with BSEN442.

AL

Vertical Panel

Finish – Anthracite, Matt Black or Matt White Material – Aluminium
All heat outputs are shown at 50°C Δt in compliance with BSEN442.

AL

Anthracite Finish							
	Height	Width	Depth	End to End Connections	Watts	Btu/hr	
LISS1800380AT	1800	380	108-117	380	1519	5183	£1176.00
LISS1800490AT	1800	490	108-117	380	1519	5183	£1458.00
LISS1800600AT	1800	600	108-117	380	1519	5183	£1739.00

Matt Black Finish							
	Height	Width	Depth	End to End Connections	Watts	Btu/hr	
LISS1800380MB	1800	380	108-117	380	1519	5183	£1155.00
LISS1800490MB	1800	490	108-117	490	1953	6664	£1429.00
LISS1800600MB	1800	600	108-117	490	1953	6664	£1708.00

Matt White Finish							
	Height	Width	Depth	End to End Connections	Watts	Btu/hr	
LISS1800380MW	1800	380	108-117	600	2387	8144	£1125.00
LISS1800490MW	1800	490	108-117	600	2387	8144	£1393.00
LISS1800600MW	1800	600	108-117	600	2387	8144	£1662.00

Anthracite Finish							
	Height	Width	Depth	End to End Connections	Watts	Btu/hr	
LISS0600600AT	600	600	108-117	600	836	2852	£796.00
LISS0600820AT	600	820	108-117	600	836	2852	£1008.00
LISS0600104AT	600	1040	108-117	600	836	2852	£1266.00
LISS0600120AT	600	1205	108-117	600	836	2852	£1450.00
LISS0600142AT	600	1425	108-117	600	836	2852	£1685.00

Matt Black Finish							
	Height	Width	Depth	End to End Connections	Watts	Btu/hr	
LISS0600600MB	600	600	108-117	820	1140	3890	£783.00
LISS0600820MB	600	820	108-117	820	1140	3890	£1013.00
LISS0600104MB	600	1040	108-117	820	1140	3890	£1244.00
LISS0600120MB	600	1205	108-117	1040	1444	3890	£1425.00
LISS0600142MB	600	1425	108-117	1040	1444	3890	£1655.00

Matt White Finish							
	Height	Width	Depth	End to End Connections	Watts	Btu/hr	
LISS0600600MW	600	600	108-117	1205	1672	5705	£763.00
LISS0600820MW	600	820	108-117	1425	1976	6742	£987.00
LISS0600104MW	600	1040	108-117	1425	1976	6742	£1211.00
LISS0600120MW	600	1205	108-117	1425	1976	6742	£1387.00
LISS0600142MW	600	1425	108-117	1425	1976	6742	£1610.00

Ovate

Please see pages 392-393 for our range of valves



Anthracite



White

Ovate Double

Finish – White or Anthracite

Material – Mild Steel

All heat outputs are shown at 50°C Δt in compliance with BSEN442.

MS

White Finish						
	Height	Width	Depth	End to End Connections	Watts	Btu/hr
OV-D180352WH	1800	352	105-110	352	1014	3460 £578.00

Anthracite Finish						
	Height	Width	Depth	End to End Connections	Watts	Btu/hr
OV-D180352AT	1800	352	105-110	352	1014	3460 £578.00

Adore

Guarantees

15 Years
on Adore



White

Please see pages 392-393 for our range of valves

Adore

Adore

Finish – White Material – Mild Steel

All heat outputs are shown at 50°C Δt in compliance with BSEN442. For details on up-grading from standard elements to Thermostatic or Remote Control, please see page 363.

MS

2 Column Radiators							
Height	Width	Depth	No. of Sections	Watts	Btu/hr		
500	460	68	10	371	1266	AD2C-050-10-0460	£355.00
500	812	68	18	688	2347	AD2C-050-18-0812	£547.00
500	988	68	22	817	2788	AD2C-050-22-0988	£646.00
600	460	68	10	440	1501	AD2C-060-10-0460	£367.00
600	636	68	14	616	2102	AD2C-060-14-0636	£468.00
600	812	68	18	792	2702	AD2C-060-18-0812	£564.00
600	1252	68	28	1232	4204	AD2C-060-28-1252	£822.00
600	988	68	22	968	3303	AD2C-060-22-0988	£663.00
600	1076	68	24	1056	3603	AD2C-060-24-1076	£722.00
1800	284	68	6	774	2641	AD2C-180-06-0284	£425.00
1800	372	68	8	1032	3521	AD2C-180-08-0372	£545.00
1800	460	68	10	1290	4401	AD2C-180-10-0460	£626.00
1800	548	68	12	1548	5282	AD2C-180-12-0548	£726.00

3 Column Radiators							
Height	Width	Depth	No. of Sections	Watts	Btu/hr		
500	636	100	14	720	2457	AD3C-050-14-0636	£545.00
500	812	100	18	926	3160	AD3C-050-18-0812	£658.00
500	988	100	22	1131	3859	AD3C-050-22-0988	£776.00
500	1076	100	24	1234	4210	AD3C-050-24-1076	£838.00
500	1252	100	28	1440	4913	AD3C-050-28-1252	£957.00
600	460	100	10	609	2078	AD3C-060-10-0460	£448.00
600	636	100	14	852	2907	AD3C-060-14-0636	£569.00
600	812	100	18	1097	3743	AD3C-060-18-0812	£692.00
600	900	100	20	1218	4156	AD3C-060-20-0900	£755.00
600	1076	100	24	1462	4988	AD3C-060-24-1076	£879.00
600	1340	100	30	1827	6234	AD3C-060-30-1340	£1066.00
750	460	100	10	750	2559	AD3C-075-10-0460	£503.00
750	636	100	14	1050	3583	AD3C-075-14-0636	£646.00
750	812	100	18	1350	4606	AD3C-075-18-0812	£790.00
750	988	100	22	1650	5630	AD3C-075-22-0988	£931.00
750	1164	100	26	1950	6653	AD3C-075-26-1164	£1084.00
1800	372	100	8	1412	4818	AD3C-180-08-0372	£641.00
1800	460	100	10	1764	6019	AD3C-180-10-0460	£757.00
1800	548	100	12	2117	7223	AD3C-180-12-0548	£875.00

4 Column Radiators							
Height	Width	Depth	No. of Sections	Watts	Btu/hr		
300	900	140	20	850	2900	AD4C-030-20-0900	£1280.00
300	1340	140	30	1275	4350	AD4C-030-30-1340	£1918.00
600	636	140	14	1147	3914	AD4C-060-14-0636	£726.00
600	812	140	18	1475	5033	AD4C-060-18-0812	£852.00
600	900	140	20	1638	5589	AD4C-060-20-0900	£931.00
600	1076	140	24	1966	6708	AD4C-060-24-1076	£1103.00
750	636	140	14	1417	4835	AD4C-075-14-0636	£800.00
750	812	140	18	1822	6217	AD4C-075-18-0812	£999.00
750	988	140	22	2227	7599	AD4C-075-22-0988	£1197.00
750	1164	140	26	2632	8980	AD4C-075-26-1164	£1400.00

Medley

Guarantees

15 Years on Medley + Skean



White



11 Section Radiator – Anthracite



Towel Bar – Chrome

Medley Towel Bar

Finish – Chrome

ME034 200CP	200mm	£98.00
ME034 340CP	340mm	£98.00
ME034 480CP	480mm	£98.00

Medley

Finish – Anthracite or White

Material – Mild Steel

All heat outputs are shown at 50°C Δt in compliance with BSEN442.

MS

Vertical – Anthracite Finish

	Height	Width	Depth	Sections	End to End Connections	Watts	Btu/hr	
ME1823A	1800	229	90	3	229	922	3146	£442.00
ME1837A	1800	370	90	5	370	1538	5248	£653.00
ME1851A	1800	507	90	7	507	2153	7346	£864.00

Horizontal – Anthracite Finish

	Height	Width	Depth	Sections	End to End Connections	Watts	Btu/hr	
ME4505A	450	507	90	7	507	398	1358	£371.00
ME4507A	450	785	90	11	785	625	2133	£495.00
ME4509A	450	993	90	14	993	796	2716	£722.00
ME4512A	450	1202	90	17	1202	966	3296	£874.00
ME5505A	550	507	90	7	507	505	1723	£420.00
ME5507A	550	785	90	11	785	793	2706	£560.00
ME5509A	550	993	90	14	993	1009	3443	£820.00
ME5512A	550	1202	90	17	1202	1226	4183	£987.00

Vertical – White Finish

	Height	Width	Depth	Sections	End to End Connections	Watts	Btu/hr	
ME1823W	1800	229	90	3	229	922	3147	£442.00
ME1837W	1800	370	90	5	370	1538	5248	£653.00
ME1851W	1800	507	90	7	507	2153	7346	£864.00

Horizontal – White Finish

	Height	Width	Depth	Sections	End to End Connections	Watts	Btu/hr	
ME4505W	450	507	90	7	507	398	1358	£371.00
ME4507W	450	785	90	11	785	625	2133	£495.00
ME4509W	450	993	90	14	993	796	2716	£722.00
ME4512W	450	1202	90	17	1202	966	3296	£874.00
ME5505W	550	507	90	7	507	505	1723	£420.00
ME5507W	550	785	90	11	785	793	2706	£560.00
ME5509W	550	993	90	14	993	1009	3443	£820.00
ME5512W	550	1202	90	17	1202	1226	4183	£987.00

Symphony

Please see pages 392-393 for our range of valves

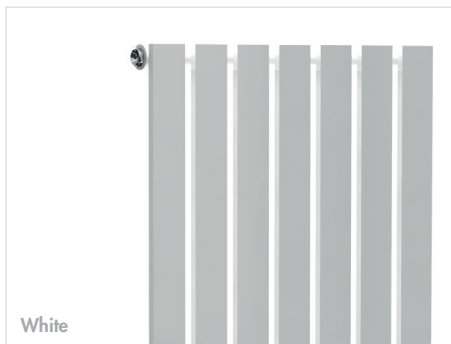
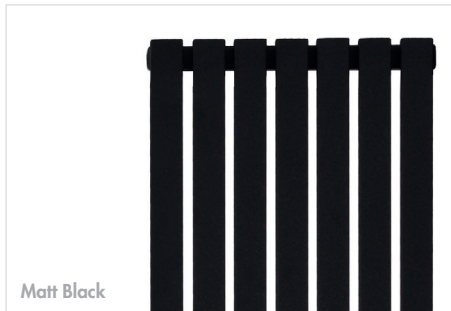

Symphony

Finish – Chrome, Matt Black or White

Material – Mild Steel

All heat outputs are shown at 50°C Δt in compliance with BSEN442.

MS

Chrome Finish								
	Height	Width	Depth	Bars	End to End Connections	Watts	Btu/hr	
SY1225C	1200	252	70	5	252	242	826	£415.00
SY1235C	1200	358	70	7	358	339	1157	£479.00
SY1825C	1800	252	70	5	252	252	1198	£490.00
SY1835C	1800	358	70	7	358	358	1675	£743.00

Matt Black Finish								
	Height	Width	Depth	Bars	End to End Connections	Watts	Btu/hr	
SY1225B	1200	252	70	5	252	252	1252	£319.00
SY1235B	1200	358	70	7	358	358	1757	£359.00
SY1825B	1800	252	70	5	252	252	1819	£387.00
SY1835B	1800	358	70	7	358	358	2545	£461.00

White Finish								
	Height	Width	Depth	Bars	End to End Connections	Watts	Btu/hr	
SY1225W	1200	252	70	5	252	367	1252	£319.00
SY1235W	1200	358	70	7	358	515	1757	£359.00
SY1825W	1800	252	70	5	252	533	1819	£387.00
SY1835W	1800	358	70	7	358	746	2545	£461.00

Symphony Towel Bar

Finish – Chrome

SY039A 266CP	266mm	£70.00
SY039B 375CP	375mm	£70.00



Alumina

Guarantees

30 Years
on Alumina

Vertical Single + Double Radiators



Single – Anthracite



Double – White

Single Vertical Panel

Finish – White or Anthracite Material – Aluminium
All heat outputs are shown at 50°C Δt in compliance with BSEN442.

AL

White Finish

	Height	Width	Depth	End to End Connections	Watts	Btu/hr	
ALV-180280WH	1800	280	76.5	280	843	2876	£405.00
ALV-180375WH	1800	375	76.5	375	1124	3835	£499.00
ALV-180470WH	1800	470	76.5	470	1405	4794	£587.00

Anthracite Finish

	Height	Width	Depth	End to End Connections	Watts	Btu/hr	
ALV-180280AT	1800	280	76.5	280	843	2876	£421.00
ALV-180375AT	1800	375	76.5	375	1124	3835	£515.00
ALV-180470AT	1800	470	76.5	470	1405	4794	£610.00

Double Vertical Panel

Finish – White or Anthracite Material – Aluminium
All heat outputs are shown at 50°C Δt in compliance with BSEN442.

AL

White Finish

	Height	Width	Depth	End to End Connections	Watts	Btu/hr	
ALVDP-180278WH	1800	278	117.5	278	1441	4917	£575.00
ALVDP-180372WH	1800	372	117.5	372	1916	6537	£710.00
ALVDP-180466WH	1800	466	117.5	466	2348	8011	£847.00

Anthracite Finish

	Height	Width	Depth	End to End Connections	Watts	Btu/hr	
ALVDP-180278AT	1800	278	117.5	278	1441	4917	£585.00
ALVDP-180372AT	1800	372	117.5	372	1916	6537	£728.00
ALVDP-180466AT	1800	466	117.5	466	2348	8011	£867.00

Please see pages 392-393 for our range of valves

Alumina

Horizontal Single + Double Radiators



Single – White

Single Horizontal Panel

Finish – White or Anthracite

Material – Aluminium

All heat outputs are shown at 50°C Δt in compliance with BSEN442.

AL

White Finish							
	Height	Width	Depth	End to End Connections	Watts	Btu/hr	
ALH-0600565WH	600	565	76.5	565	506	1726	£383.00
ALH-0600755WH	600	755	76.5	755	674	2300	£468.00
ALH-0600945WH	600	945	76.5	945	842	2873	£552.00
ALH-0601135WH	600	1135	76.5	1135	1011	3450	£634.00
ALH-0601325WH	600	1325	76.5	1325	1147	3914	£719.00
ALH-0601515WH	600	1515	76.5	1515	1342	4579	£800.00

Anthracite Finish							
	Height	Width	Depth	End to End Connections	Watts	Btu/hr	
ALH-0600565AT	600	565	76.5	565	506	1726	£394.00
ALH-0600755AT	600	755	76.5	755	674	2300	£478.00
ALH-0600945AT	600	945	76.5	945	842	2873	£568.00
ALH-0601135AT	600	1135	76.5	1135	1011	3450	£656.00
ALH-0601325AT	600	1325	76.5	1325	1147	3914	£741.00
ALH-0601515AT	600	1515	76.5	1515	1342	4579	£828.00

Double Horizontal Panel

Finish – White or Anthracite

Material – Aluminium

All heat outputs are shown at 50°C Δt in compliance with BSEN442.

AL

White Finish							
	Height	Width	Depth	End to End Connections	Watts	Btu/hr	
ALHDP-0600560WH	600	560	117.5	560	841	2869	£498.00
ALHDP-0600748WH	600	748	117.5	748	1121	3825	£610.00
ALHDP-0600936WH	600	936	117.5	936	1401	4780	£723.00
ALHDP-0601124WH	600	1124	117.5	1124	1654	5643	£861.00
ALHDP-0601312WH	600	1312	117.5	1312	1908	6510	£979.00

Anthracite Finish							
	Height	Width	Depth	End to End Connections	Watts	Btu/hr	
ALHDP-0600560AT	600	560	117.5	560	841	2869	£505.00
ALHDP-0600748AT	600	748	117.5	748	1121	3825	£622.00
ALHDP-0600936AT	600	936	117.5	936	1401	4780	£739.00
ALHDP-0601124AT	600	1124	117.5	1124	1654	5643	£878.00
ALHDP-0601312AT	600	1312	117.5	1312	1908	6510	£1000.00

Espada Aluminium

Guarantees

30 Years
on Espada Aluminium

Vertical Radiators



Single - White



Single - Anthracite

Single Vertical Panel

Finish - White or Anthracite
Material - Aluminium
All heat outputs are shown at 50°C Δt in compliance with BSEN442.

AL

White Finish

	Height	Width	Depth	End to End Connections	Watts	Btu/hr	
ESAL-V1800218WH	1800	220	66	220	642	2190	£340.00
ESAL-V1800366WH	1800	370	66	370	1070	3651	£517.00
ESAL-V1800514WH	1800	520	66	520	1499	5113	£693.00
ESAL-V1800662WH	1800	670	66	670	1927	6574	£869.00

Anthracite Finish

	Height	Width	Depth	End to End Connections	Watts	Btu/hr	
ESAL-V1800218AT	1800	220	66	220	642	2190	£340.00
ESAL-V1800366AT	1800	370	66	370	1070	3651	£517.00
ESAL-V1800514AT	1800	520	66	520	1499	5113	£693.00
ESAL-V1800662AT	1800	670	66	670	1927	6574	£869.00

Double Vertical Panel

Finish - White or Anthracite
Material - Aluminium
All heat outputs are shown at 50°C Δt in compliance with BSEN442.

AL

White Finish

	Height	Width	Depth	End to End Connections	Watts	Btu/hr	
ESAL-VDP1800218WH	1800	220	91.5	220	1109	3783	£469.00
ESAL-VDP1800366WH	1800	370	91.5	370	1849	6308	£728.00
ESAL-VDP1800514WH	1800	520	91.5	520	2589	8833	£987.00
ESAL-VDP1800662WH	1800	670	91.5	670	3329	11358	£1247.00

Anthracite Finish

	Height	Width	Depth	End to End Connections	Watts	Btu/hr	
ESAL-VDP1800218AT	1800	220	91.5	220	1109	3783	£469.00
ESAL-VDP1800366AT	1800	370	91.5	370	1849	6308	£728.00
ESAL-VDP1800514AT	1800	520	91.5	520	2589	8833	£987.00
ESAL-VDP1800662AT	1800	670	91.5	670	3329	11358	£1247.00

Please see pages 392-393 for our range of valves

Espada Aluminium

Horizontal Radiators



Double – White



Double – Anthracite

Single Horizontal Panel

Finish – White or Anthracite

Material – Aluminium

All heat outputs are shown at 50°C Δt in compliance with BSEN442.

AL

White Finish							
	Height	Width	Depth	Pipe Centres	Watts	Btu/hr	
ESAL-H0440900WH	450	900	75	870	680	2319	£361.00
ESAL-H04401200WH	450	1200	75	1150	881	3006	£442.00
ESAL-H0588900WH	595	900	75	870	906	3092	£458.00
ESAL-H05881200WH	595	1200	75	1150	1175	4009	£566.00

Anthracite Finish							
	Height	Width	Depth	Pipe Centres	Watts	Btu/hr	
ESAL-H0440900AT	450	900	75	870	680	2319	£361.00
ESAL-H04401200AT	450	1200	75	1150	881	3006	£442.00
ESAL-H0588900AT	595	900	75	870	906	3092	£458.00
ESAL-H05881200AT	595	1200	75	1150	1175	4009	£566.00

Double Horizontal Panel

Finish – White or Anthracite

Material – Aluminium

All heat outputs are shown at 50°C Δt in compliance with BSEN442.

AL

White Finish							
	Height	Width	Depth	Pipe Centres	Watts	Btu/hr	
ESAL-HDP0440900WH	450	900	122	870	1161	3960	£521.00
ESAL-HDP04401200WH	450	1200	122	1150	1513	5163	£633.00
ESAL-HDP0588900WH	595	900	122	870	1548	5281	£671.00
ESAL-HDP05881200WH	595	1200	122	1150	2018	6886	£819.00

Anthracite Finish							
	Height	Width	Depth	Pipe Centres	Watts	Btu/hr	
ESAL-HDP0440900AT	450	900	122	870	1161	3960	£521.00
ESAL-HDP04401200AT	450	1200	122	1150	1513	5163	£633.00
ESAL-HDP0588900AT	595	900	122	870	1548	5281	£671.00
ESAL-HDP05881200AT	595	1200	122	1150	2018	6886	£819.00

Espada

Guarantees

15 Years on Espada

Vertical Radiators



Single Panel

Finish – White or Anthracite
 Material – Mild Steel
 All heat outputs are shown at 50°C Δt in compliance with BSEN442.

MS

White Finish

	Height	Width	Depth	Watts	Btu/hr	
ES-V180228WH	1800	224	71	402	1372	£307.00
ES-V180376WH	1800	376	71	670	2286	£421.00
ES-V180524WH	1800	528	71	938	3200	£533.00
ES-V180672WH	1800	680	71	1206	4115	£643.00

Anthracite Finish

	Height	Width	Depth	Watts	Btu/hr	
ES-V180228AT	1800	224	71	402	1372	£311.00
ES-V180376AT	1800	376	71	670	2286	£424.00
ES-V180524AT	1800	528	71	938	3200	£538.00
ES-V180672AT	1800	680	71	1206	4115	£651.00

Double Panel

Finish – White or Anthracite
 Material – Mild Steel
 All heat outputs are shown at 50°C Δt in compliance with BSEN442.

MS

White Finish

	Height	Width	Depth	Watts	Btu/hr	
ES-VDP180228WH	1800	224	71	627	2139	£488.00
ES-VDP180376WH	1800	376	71	1045	3566	£710.00
ES-VDP180524WH	1800	528	71	1463	4992	£933.00
ES-VDP180672WH	1800	680	71	1881	6418	£1154.00

Anthracite Finish

	Height	Width	Depth	Watts	Btu/hr	
ES-VDP180228AT	1800	224	71	627	2139	£490.00
ES-VDP180376AT	1800	376	71	1045	3566	£715.00
ES-VDP180524AT	1800	528	71	1463	4992	£938.00
ES-VDP180672AT	1800	680	71	1881	6418	£1161.00

Double – White

Espada

Please see pages 392-393 for our range of valves

Horizontal Radiators



Single – Anthracite

Single Panel

Finish – White or Anthracite

Material – Mild Steel

All heat outputs are shown at 50°C Δt in compliance with BSEN442.

MS

White Finish

	Height	Width	Depth	Watts	Btu/hr	
ES-H0450090WH	452	900	63	420	1433	£349.00
ES-H0450120WH	452	1200	63	552	1883	£394.00
ES-H0598090WH	604	900	63	560	1911	£422.00
ES-H0598120WH	604	1200	63	736	2511	£481.00

Anthracite Finish

	Height	Width	Depth	Watts	Btu/hr	
ES-H0450090AT	452	900	63	420	1433	£352.00
ES-H0450120AT	452	1200	63	552	1883	£400.00
ES-H0598090AT	604	900	63	560	1911	£425.00
ES-H0598120AT	604	1200	63	736	2511	£486.00

Double Panel

Finish – White or Anthracite

Material – Mild Steel

All heat outputs are shown at 50°C Δt in compliance with BSEN442.

MS

White Finish

	Height	Width	Depth	Watts	Btu/hr	
ES-HDP0450090WH	452	900	112	654	2231	£591.00
ES-HDP0450120WH	452	1200	112	858	2927	£674.00
ES-HDP0598090WH	604	900	112	872	2975	£742.00
ES-HDP0598120WH	604	1200	112	1144	3903	£849.00

Anthracite Finish

	Height	Width	Depth	Watts	Btu/hr	
ES-HDP0450090AT	452	900	112	654	2231	£594.00
ES-HDP0450120AT	452	1200	112	858	2927	£677.00
ES-HDP0598090AT	604	900	112	872	2975	£745.00
ES-HDP0598120AT	604	1200	112	1144	3903	£855.00

Radiator Valves

Guarantees

1 Year
on Radiator Valves**Modern 15mm Angled Radiator Valves (Pair)**Finish – Polished Chrome
Dimensions – 90.5(h) x 75(w) x 32(d) mm

INST-AL025LC

£40.00

**Modern 15mm Straight Radiator Valves (Pair)**Finish – Polished Chrome
Dimensions – 75(h) x 87.5(w) x 32(d) mm

INST-AL024LC

£40.00

**15mm Corner Radiator Valves (Pair)**Finish – Polished Chrome
Dimensions – 75(h) x 60(w) x 75(d) mm

INST-AL029LC

£45.00

**Square 15mm Decorative Angled Radiator Valves (Pair)**Finish – Polished Chrome
Dimensions – 82(h) x 76(w) x 30(d) mm

INST-AL030LC

£75.00

**Square 15mm Decorative Straight Radiator Valves (Pair)**Finish – Polished Chrome
Dimensions – 64(h) x 95(w) x 30(d) mm

INST-AL031LC

£75.00

**Art Deco Angled Radiator Valve 1/2" x 15mm (Pair)**Finish – Chrome
Dimensions – 126(h) x 80(w) x 64(d) mm

INTRAD006

£94.00

**Crosshead Angled Traditional Radiator Valve 1/2" x 15mm (Pair)**Finish – Polished Chrome
Dimensions – 110(h) x 115(w) x 46(d) mm

INST-AL034LC

£66.00

**Classic Thermostatic 15mm Radiator Valve + Air Vent (Twin Pack)**Finish – Polished Chrome
Dimensions – 139(h) x 56(w) x 55(d) mm

INST-AL055LC

£128.00

**Crosshead Capstan Style Angled Radiator Valve 1/2" x 15mm (Pair)**Finish – Chrome
Dimensions – 111(h) x 90(w) x 70(d) mm

INTRAD018

£82.00

Radiator Valves



15mm Angled TRV (Twin Pack)

Finish – Chrome
Dimensions – 130(h) x 42(w) x 65(d) mm

15PACKACP.1

£28.00



15mm Straight TRV (Twin Pack)

Finish – Chrome
Dimensions – 120(h) x 47(w) x 86(d) mm

15PACKSCP.1

£30.00



15mm Corner TRV + LS Pack

Finish – Chrome

TRVCNR

£49.00



Modern Thermostatic Radiator Valves Angled 1/2" x 15mm

Finish – Black or Anthracite
Dimensions – 136(h) x 68(w) x 40(d) mm

INCNT004AP-BL Black £89.00

INCNT004AP-AT Anthracite £89.00



Modern Thermostatic Radiator Valves Straight 1/2" x 15mm

Finish – Black or Anthracite
Dimensions – 84(h) x 118(w) x 40(d) mm

INCNT004ST-BL Black £89.00

INCNT004ST-AT Anthracite £89.00



Modern Thermostatic Corner Radiator Valves 1/2" x 15mm

Finish – Black or Anthracite
Dimensions – 84(h) x 118(w) x 40(d) mm

INCNT024-BL Black £94.00

INCNT024-AT Anthracite £94.00



15mm Pipe Cover Set (Pair)

Finish – Polished Chrome
Dimensions – 130(h) x 51(w) x 51(d) mm

INST-AL033LC

£26.00

INSTINCT®

Are you looking for
other colour options?

Please see pages 362 – 363 for
alternative colour options in –

Straight Valves

Angled Valves

Corner Valves

Pipe Connection Tubes



new

Modern Thermostatic Radiator Valves Angled 1/2" x 15mm

Finish – Brushed Brass
Dimensions – 136(h) x 68(w) x 40(d) mm

INCNT004AP-ZBBS

£120.00